

Model Name: T240XW01 V1

Issue Date : 2010/03/05

() Preliminary Specifications

(*) Final Specifications

Customer Signature	Date	AUO	Date
Approved By		Approval By PM Director Frank Hsu <i>Frank Hsu. 2010.3.29</i>	
Note		Reviewed By RD Director Eugene CC Chen <i>Eugene Chen 2010 3/25</i>	
		Reviewed By Project Leader Alain Wu <i>Alain Wu</i>	
		Prepared By PM Fanglan Hsu <i>Fanglan Hsu</i>	

Contents

No		
		CONTENTS
		RECORD OF REVISIONS
1		GENERAL DESCRIPTION
2		ABSOLUTE MAXIMUM RATINGS
3		ELECTRICAL SPECIFICATION
	3-1	ELECTRICAL CHARACTERISTICS
	3-2	INTERFACE CONNECTIONS
	3-3	SIGNAL TIMING SPECIFICATION
	3-4	SIGNAL TIMING WAVEFORMS
	3-5	COLOR INPUT DATA REFERENCE
	3-6	POWER SEQUENCE FOR LCD
4		OPTICAL SPECIFICATION
5		OPEN CELL DRAWING
6		RELIABILITY TEST ITEMS
7		AUO's Basic BLU Optical Performance
8		PACKING
	8-1	DEFINITION OF LABEL
	8-2	PACKING METHODS
9		PRECAUTION
	9-1	MOUNTING PRECAUTIONS
	9-2	OPERATING PRECAUTIONS
	9-3	ELECTROSTATIC DISCHARGE CONTROL
	9-4	PRECAUTIONS FOR STRONG LIGHT EXPOSURE
	9-5	STORAGE
	9-6	HANDLING PRECAUTIONS FOR PROTECT FILM OF POLARIZER

1. General Description

This specification applies to the 24 inch Color TFT-LCD SKD T240XW01 V1. This LCD Open Cell Unit has a TFT active matrix type liquid crystal panel 1,366x768 pixels, and diagonal size of 24.02 inch. This module supports 1,366x768 mode. Each pixel is divided into Red, Green and Blue sub-pixels or dots which are arranged in horizontal stripes. Gray scale or the brightness of the sub-pixel color is determined with a 8-bit gray scale signal for each dot.

The T240XW01 V1 has been designed to apply the 8-bit and 1 channel LVDS interface method. It is intended to support displays where high brightness, wide viewing angle, high color saturation, and high color depth are very important.

* General Information

Item	Specification	Unit	Note
Active Screen Size	24.02	[Inch]	-
Display Area	531.7155 (H) x 298.944 (V)	[mm]	-
Outline Dimension	546.80 (H) x 314.10 (V) x 1.8 (D)	[mm]	-
Resolution	1,366 x 768	[pixel]	-
Pixel Pitch	0.38925	[mm]	-
Pixel Arrangement	RGB horizontal stripe	-	-
Display mode	Normally Black	-	-
Display Colors	16.7M (8-bit for R,G,B)	[color]	-
Surface Treatment	AG, Haze=11%, 3H	-	-

2. Absolute Maximum Ratings

The followings are maximum values which, if exceeded, may cause faulty operation or damage to the unit

Item	Symbol	Min	Max	Unit	Note
Logic/LCD Drive Voltage	Vdd	-0.3	6	[Volt]	1
Input Voltage of Signal	Vin	-0.3	4	[Volt]	1
Operating Temperature	TOP	0	+50	[°C]	2
Operating Humidity	HOP	10	90	[%RH]	2
Storage Temperature	TST	-20	+60	[°C]	2
Storage Humidity	HST	10	90	[%RH]	2
Panel Surface Temperature	PST		65	[°C]	3

Note 1: Duration: 50 msec.

Note 2: Maximum Wet-Bulb should be 39°C and No condensation.

The relative humidity must not exceed 90% non-condensing at temperatures of 40°C or less. At temperatures greater than 40°C, the wet bulb temperature must not exceed 39°C.

Note 3: Surface temperature is measured at 50°C Dry condition



3. Electrical Specification

The T240XW01 V1 requires two power inputs. One is employed to power the LCD electronics and to drive the TFT array and liquid crystal. The second input for BLU is to power inverter.

3.1 Electrical Characteristics

Parameter		Symbol	Value			Unit	Note
			Min.	Typ.	Max		
LCD							
Power Supply Input Voltage		V_{DD}	4.5	5	5.5	V_{DC}	1
Power Supply Input Current		I_{DD}	--	0.65	0.8	A	2
Power Consumption		P_C	--	3.25	4.0	Watt	2
Inrush Current		I_{RUSH}	--	--	3	A	3
LVDS Interface	Input Differential Voltage	$ V_{ID} $	200	400	600	mV_{DC}	4
	Differential Input High Threshold Voltage	V_{TH}	--	--	+100	mV_{DC}	4
	Differential Input Low Threshold Voltage	V_{TL}	-100	--	--	mV_{DC}	4
	Input Common Mode Voltage	V_{ICM}	1.1	1.25	1.4	V_{DC}	4
CMOS Interface	Input High Threshold Voltage	V_{IH} (High)	2.7	--	3.3	V_{DC}	
	Input Low Threshold Voltage	V_{IL} (Low)	0	--	0.6	V_{DC}	

Note :

1. The ripple voltage should be controlled under 10% of V_{CC}
2. $V_{DD} = 5.0V$, $F_v = 60Hz$, $F_{CLK} = 82MHz$, $25^\circ C$, Test Pattern : White Pattern
3. Measurement condition : Rising time = 400us

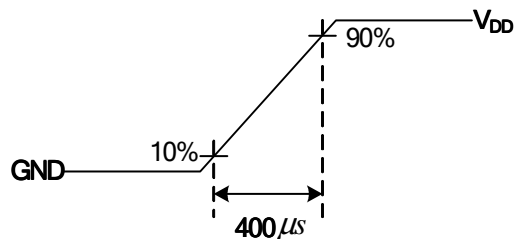

4. $V_{ICM} = 1.25V$

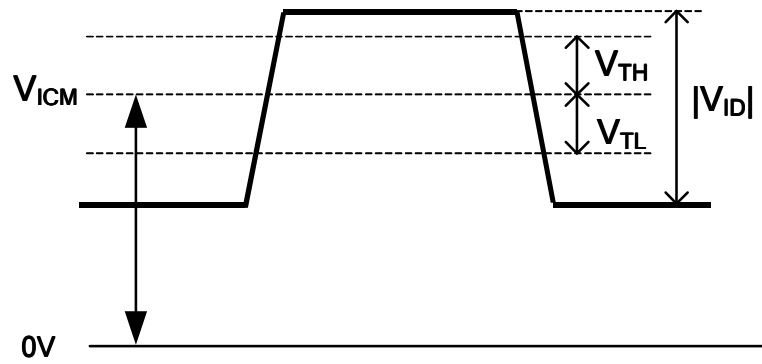

3.2 Interface Connections

LCD connector (CN1): STARCON 106F30_000000_A2_R

PIN	Symbol	Description
1	Reserved	AUO Internal Use Only
2	Reserved	AUO Internal Use Only
3	Reserved	AUO Internal Use Only
4	GND	Ground
5	CH1_0-	LVDS Channel, Signal 0-
6	CH1_0+	LVDS Channel, Signal 0+
7	GND	Ground
8	CH1_1-	LVDS Channel, Signal 1-
9	CH1_1+	LVDS Channel, Signal 1+
10	GND	Ground
11	CH1_2-	LVDS Channel, Signal 2-
12	CH1_2+	LVDS Channel, Signal 2+
13	GND	Ground
14	CH1_CLK-	LVDS Channel, Clock -
15	CH1_CLK+	LVDS Channel, Clock +
16	GND	Ground
17	CH1_3-	LVDS Channel, Signal 3-
18	CH1_3+	LVDS Channel, Signal 3+
19	GND	Ground
20	NC	No connection
21	LVDS_SEL	Open/High(3.3V) for NS, Low(GND) for JEIDA
22	NC	No connection
23	GND	Ground
24	GND	Ground
25	GND	Ground
26	V _{DD}	Power Supply, +5V DC Regulated
27	V _{DD}	Power Supply, +5V DC Regulated
28	V _{DD}	Power Supply, +5V DC Regulated
29	V _{DD}	Power Supply, +5V DC Regulated
30	V _{DD}	Power Supply, +5V DC Regulated

Note :

1. All GND (ground) pins should be connected together and should also be connected to the LCD's metal frame.
2. All Vcc (power input) pins should be connected together.

■ LVDS Option = High/Open→NS

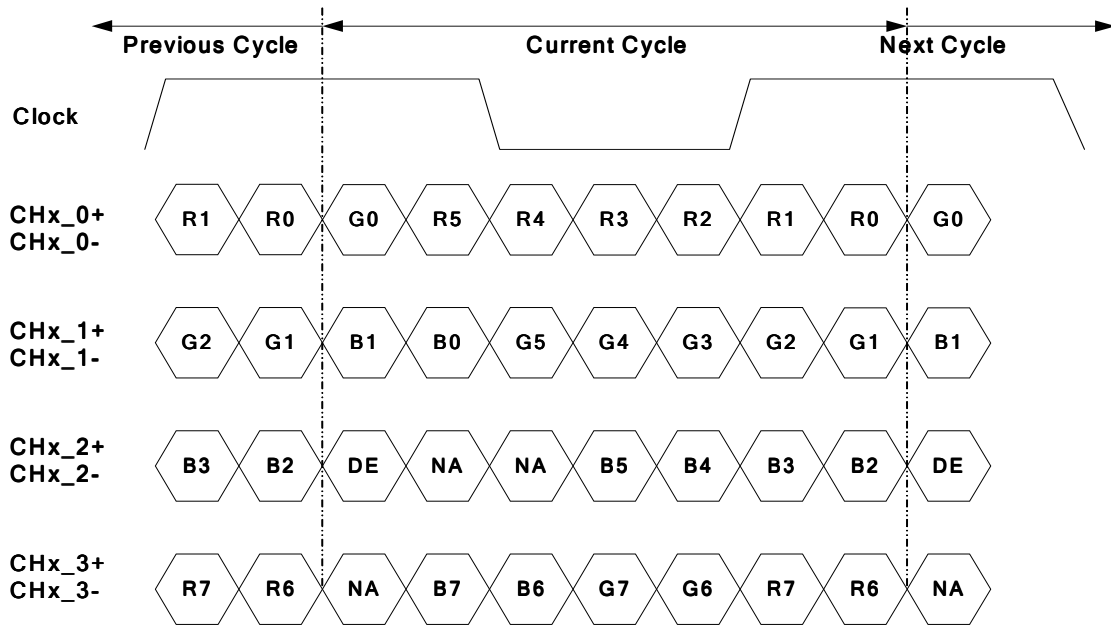

Note: x = 1, 2, 3, 4...

■ LVDS Option = Low→JEIDA

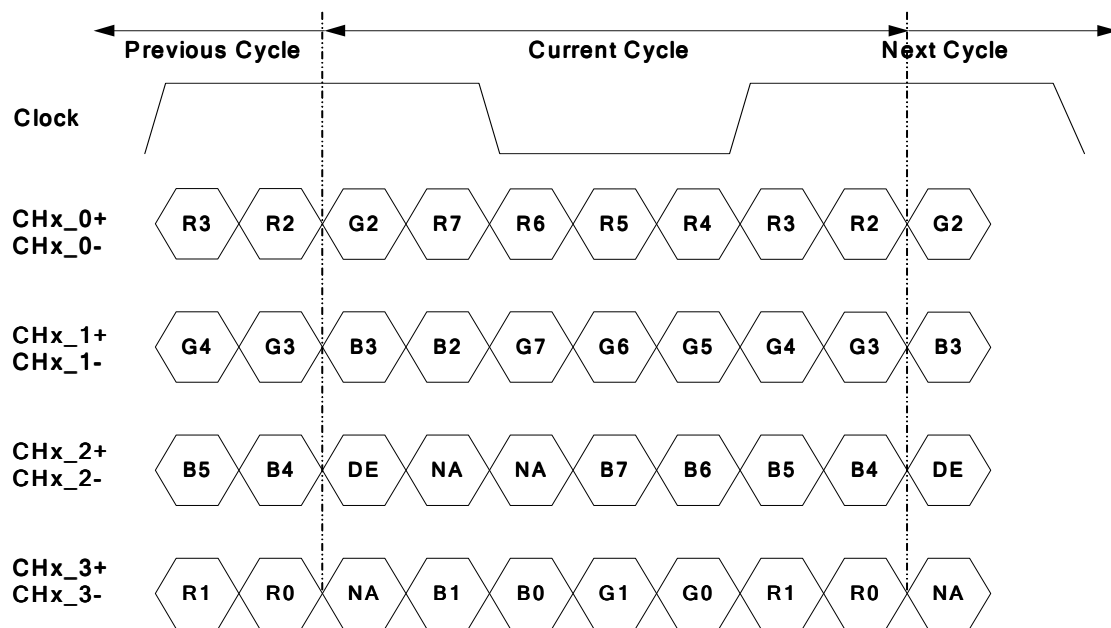

Note: x = 1, 2, 3, 4...

3.3 Signal Timing Specification

This is the signal timing required at the input of the user connector. All of the interface signal timing should be satisfied with the following specifications for its proper operation.

Signal	Item	Symbol	Min.	Typ.	Max	Unit
Vertical Section	Period	Tv	784	810	1,015	[Th]
	Active	Tdisp (v)	768			[Th]
	Blanking	Tblk (v)	16	42	247	[Th]
Horizontal Section	Period	Th	1,460	1,648	2,000	[Tclk]
	Active	Tdisp (h)	1,366			[Tclk]
	Blanking	Tblk (h)	94	282	634	[Tclk]
Clock	Frequency	Fclk=1/Tclk	50	80	86	[MHz]
Vertical Frequency	Frequency	Fv	47	60	63	[Hz]
Horizontal Frequency	Frequency	Fh	43	48	53	[KHz]

Notes:

(1) Display position is specific by the rise of DE signal only.

Horizontal display position is specified by the rising edge of 1st DCLK after the rise of 1st DE, is displayed on the left edge of the screen.

(2) Vertical display position is specified by the rise of DE after a “Low” level period equivalent to eight times of horizontal period. The 1st data corresponding to one horizontal line after the rise of 1st DE is displayed at the top line of screen.

(3) If a period of DE “High” is less than 1366 DCLK or less than 768 lines, the rest of the screen displays black.

(4) The display position does not fit to the screen if a period of DE “High” and the effective data period do not synchronize with each other.

3.4 Signal Timing Waveforms

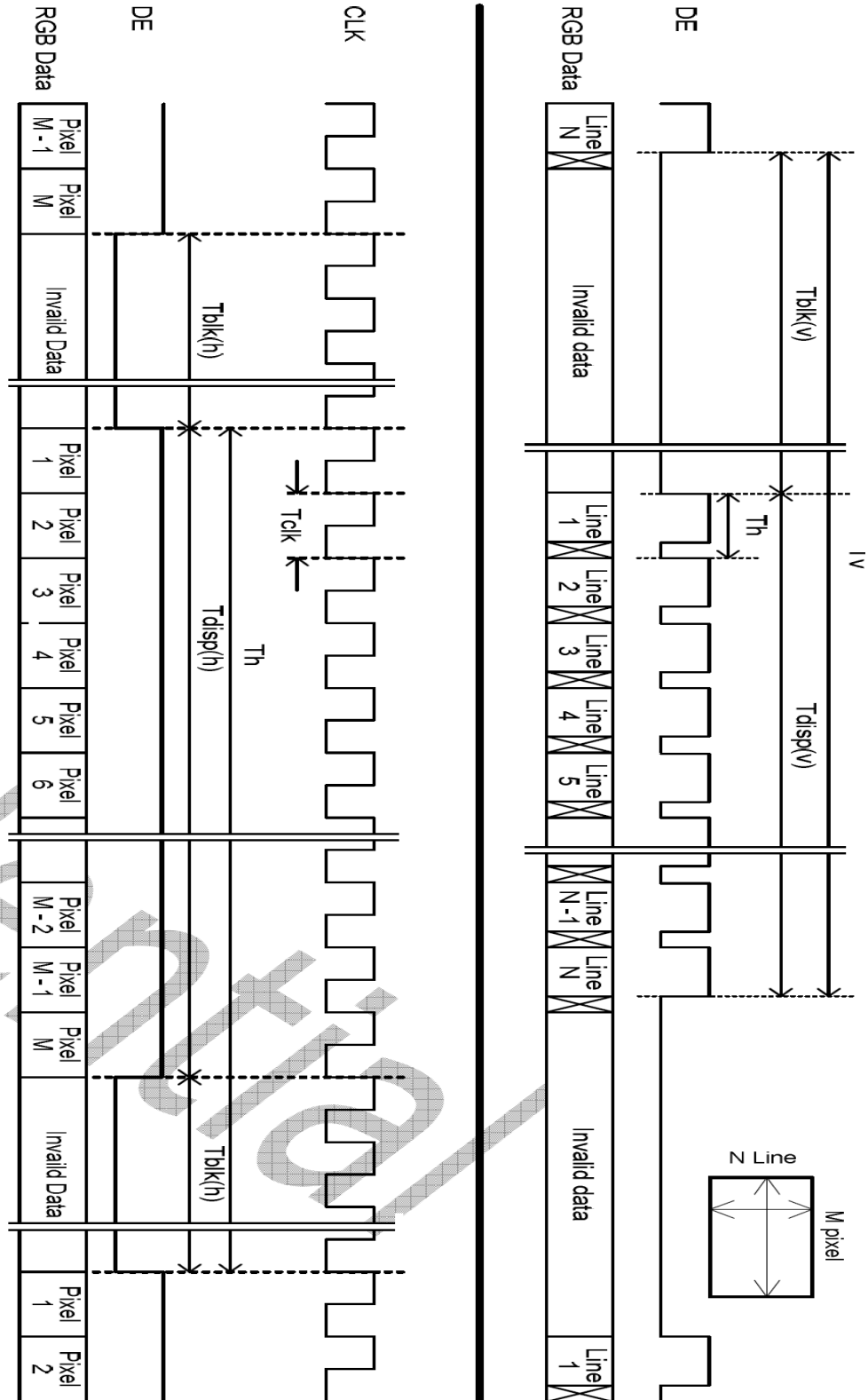

3.5 Color Input Data Reference

The brightness of each primary color (red, green and blue) is based on the 8 bit gray scale data input for the color; the higher the binary input, the brighter the color. The table below provides a reference for color versus data input.

COLOR DATA REFERENCE

Color		Input Color Data																							
		RED								GREEN								BLUE							
		MSB				LSB				MSB				LSB				MSB				LSB			
		R7	R6	R5	R4	R3	R2	R1	R0	G7	G6	G5	G4	G3	G2	G1	G0	B7	B6	B5	B4	B3	B2	B1	B0
Basic Color	Black	0	0	0	0	0	0	0	0	0	0	0	0	0	0	0	0	0	0	0	0	0	0	0	0
	Red(255)	1	1	1	1	1	1	1	1	0	0	0	0	0	0	0	0	0	0	0	0	0	0	0	0
	Green(255)	0	0	0	0	0	0	0	0	1	1	1	1	1	1	1	1	0	0	0	0	0	0	0	0
	Blue(255)	0	0	0	0	0	0	0	0	0	0	0	0	0	0	0	0	1	1	1	1	1	1	1	1
	Cyan	0	0	0	0	0	0	0	0	1	1	1	1	1	1	1	1	1	1	1	1	1	1	1	1
	Magenta	1	1	1	1	1	1	1	1	0	0	0	0	0	0	0	0	1	1	1	1	1	1	1	1
	Yellow	1	1	1	1	1	1	1	1	1	1	1	1	1	1	1	1	0	0	0	0	0	0	0	0
	White	1	1	1	1	1	1	1	1	1	1	1	1	1	1	1	1	1	1	1	1	1	1	1	1
R	RED(000)	0	0	0	0	0	0	0	0	0	0	0	0	0	0	0	0	0	0	0	0	0	0	0	0
	RED(001)	0	0	0	0	0	0	0	1	0	0	0	0	0	0	0	0	0	0	0	0	0	0	0	0

	RED(254)	1	1	1	1	1	1	1	0	0	0	0	0	0	0	0	0	0	0	0	0	0	0	0	0
	RED(255)	1	1	1	1	1	1	1	1	0	0	0	0	0	0	0	0	0	0	0	0	0	0	0	0
G	GREEN(000)	0	0	0	0	0	0	0	0	0	0	0	0	0	0	0	0	0	0	0	0	0	0	0	0
	GREEN(001)	0	0	0	0	0	0	0	0	0	0	0	0	0	0	1	0	0	0	0	0	0	0	0	0

	GREEN(254)	0	0	0	0	0	0	0	0	1	1	1	1	1	1	1	0	0	0	0	0	0	0	0	0
	GREEN(255)	0	0	0	0	0	0	0	0	1	1	1	1	1	1	1	1	0	0	0	0	0	0	0	0
B	BLUE(000)	0	0	0	0	0	0	0	0	0	0	0	0	0	0	0	0	0	0	0	0	0	0	0	0
	BLUE(001)	0	0	0	0	0	0	0	0	0	0	0	0	0	0	0	0	0	0	0	0	0	0	0	1

	BLUE(254)	0	0	0	0	0	0	0	0	0	0	0	0	0	0	0	0	1	1	1	1	1	1	1	0
	BLUE(255)	0	0	0	0	0	0	0	0	0	0	0	0	0	0	0	0	1	1	1	1	1	1	1	1

3.6 Power Sequence for LCD

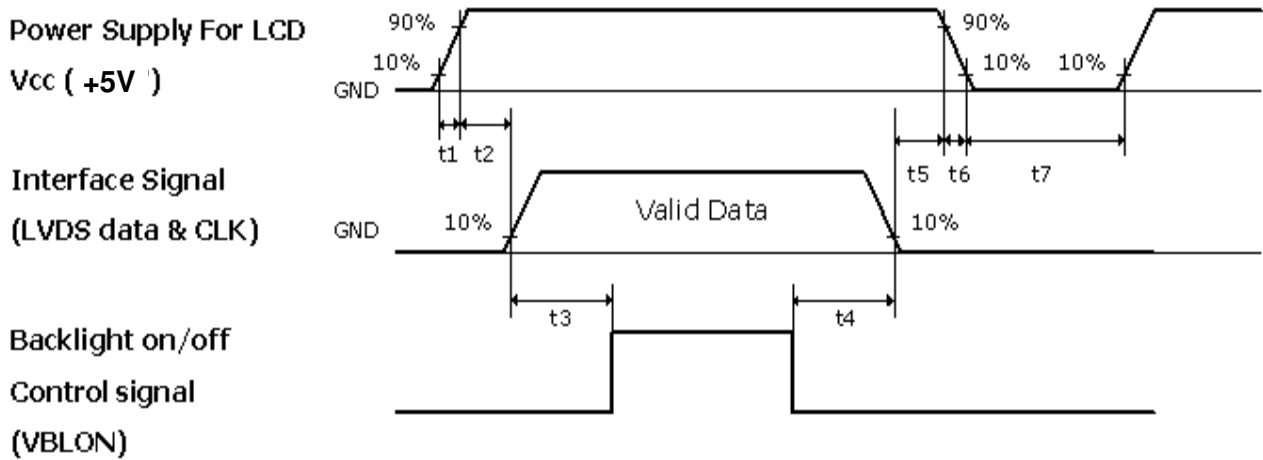

Parameter	Values			Unit
	Min.	Typ.	Max.	
t1	0.4	-	30	[ms]
t2	0.1	-	50	[ms]
t3	200	-	-	[ms]
t4	0 ^{*1}	-	-	[ms]
t5	0	-	-	[ms]
t6	-	-	- ^{*2}	[ms]
t7	500	-	-	[ms]

Note:

- (1) T4=0 : concern for residual pattern before BLU turn off.
- (2) T6 : voltage of VDD must decay smoothly after power-off. (customer system decide this value)

Apply the lamp voltage within the LCD operating range. When the backlight turns on before the LCD operation or the LCD turns off before the backlight turns off, the display may momentarily become abnormal.

Caution: The above on/off sequence should be applied to avoid abnormal function in the display. In case of handling, make sure to turn off the power when you plug the cable into the input connector or pull the cable out of the connector.

4. Optical Specification

Optical characteristics are determined after the unit has been 'ON' and stable for approximately 45 minutes in a dark environment at 25°C. The values specified are at an approximate distance 50cm from the LCD surface at a viewing angle of ϕ and θ equal to 0°.

Fig.1 presents additional information concerning the measurement equipment and method.

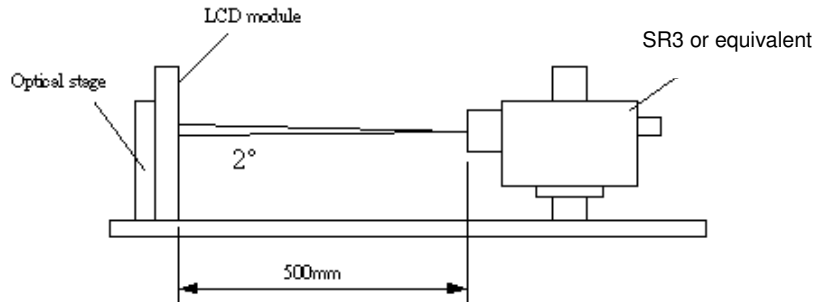

Parameter	Symbol	Values			Unit	Notes	
		Min.	Typ.	Max			
Contrast Ratio	CR	1600	2,000	-	-	1, 2	
Surface Luminance (White)	L_{WH}	240	300	-	[cd/m ²]	1, 3	
Luminance Variation	$\delta_{WHITE(\theta P)}$	-	-	1.3	-	1, 4	
Cell Transparency	Tr		4.3		%	1, 7	
Response Time (G to G)	T _y	-	8	-	[ms]	1, 5	
Color Gamut	NTSC	-	72	-	[%]	1	
Color Coordinates							
	Red	R _x	Typ.-0.03	0.64	Typ.+0.03	1	
		R _y		0.33		1	
	Green	G _x		0.29		1	
		G _y		0.60		1	
	Blue	B _x		0.15		1	
		B _y		0.06		1	
	White	W _x		0.29		1	
W _y		0.30	1				
Viewing Angle							
	x axis, right($\phi=0^\circ$)	θ_r	--	89	--	degree	6
	x axis, left($\phi=180^\circ$)	θ_l	--	89	--	degree	6
	y axis, up($\phi=90^\circ$)	θ_u	--	89	--	degree	6
	y axis, down ($\phi=270^\circ$)	θ_d	--	89	--	degree	6

Note:

1. The measured optical data is based on AUO BLU unit.
2. Contrast Ratio (CR) is defined mathematically as:

$$\text{Contrast Ratio} = \frac{\text{Surface Luminance of } L_{on5}}{\text{Surface Luminance of } L_{off5}}$$

3. Surface luminance is luminance value at point 5 across the LCD surface 50cm from the surface with all pixels displaying white. From more information see FIG 2. When lamp current $I_H = 11\text{mA}$. $L_{WH} = L_{on5}$ where L_{on5} is the luminance with all pixels displaying white at center 5 location.

4. The variation in surface luminance, δ_{WHITE} is defined (center of Screen) as:

$$\delta_{WHITE(9P)} = \text{Maximum}(L_{on1}, L_{on2}, \dots, L_{on9}) / \text{Minimum}(L_{on1}, L_{on2}, \dots, L_{on9})$$

5. Response time T_γ is the average time required for display transition by switching the input signal for five luminance ratio (0%,25%,50%,75%,100% brightness matrix) and is based on $F_v=60\text{Hz}$ to optimize.

Measured Response Time		Target				
		0%	25%	50%	75%	100%
Start	0%		0% to 25%	0% to 50%	0% to 75%	0% to 100%
	25%	25% to 0%		25% to 50%	25% to 75%	25% to 100%
	50%	50% to 0%	50% to 25%		50% to 75%	50% to 100%
	75%	75% to 0%	75% to 25%	75% to 50%		75% to 100%
	100%	100% to 0%	100% to 25%	100% to 50%	100% to 75%	

6. Viewing angle is the angle at which the contrast ratio is greater than 10. The angles are determined for the horizontal or x axis and the vertical or y axis with respect to the z axis which is normal to the LCD surface. For more information see FIG3.
7. Cell Transparency (T_r) is the ratio of module luminance at center point of active area to backlight luminance at center point. T_r is defined as, $T_r (\%) = (\text{Module luminance} / \text{Backlight luminance}) \times 100$. Where the film structure of backlight should not include any reflective type of prism such as DBEFD, and Measurement of module or backlight luminance should be under the same condition of BLU power and no any lamp mura is found.

FIG. 2 Luminance

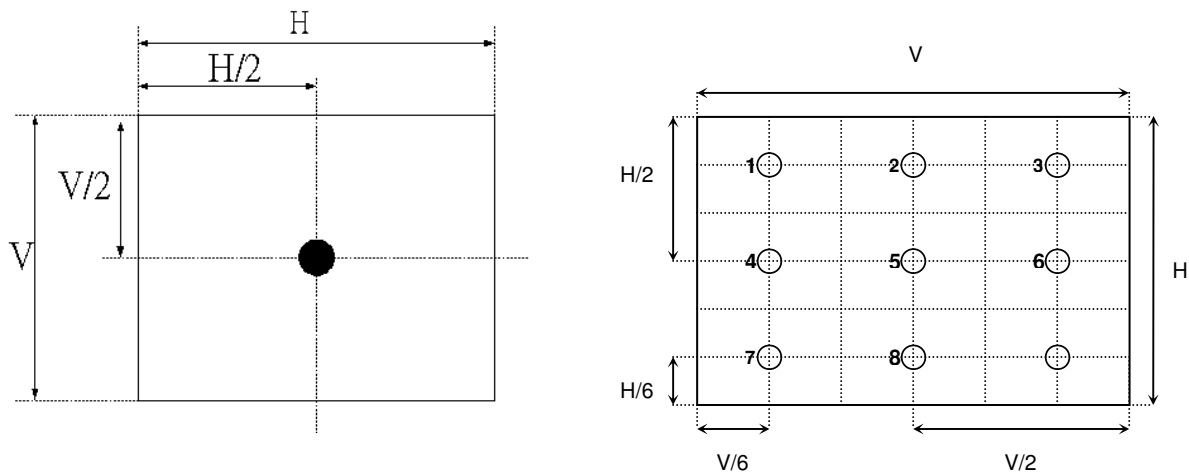
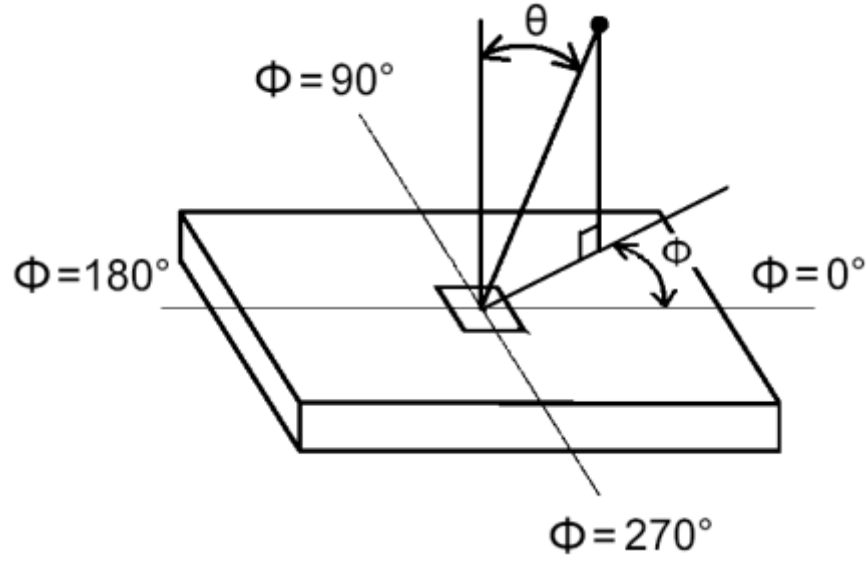
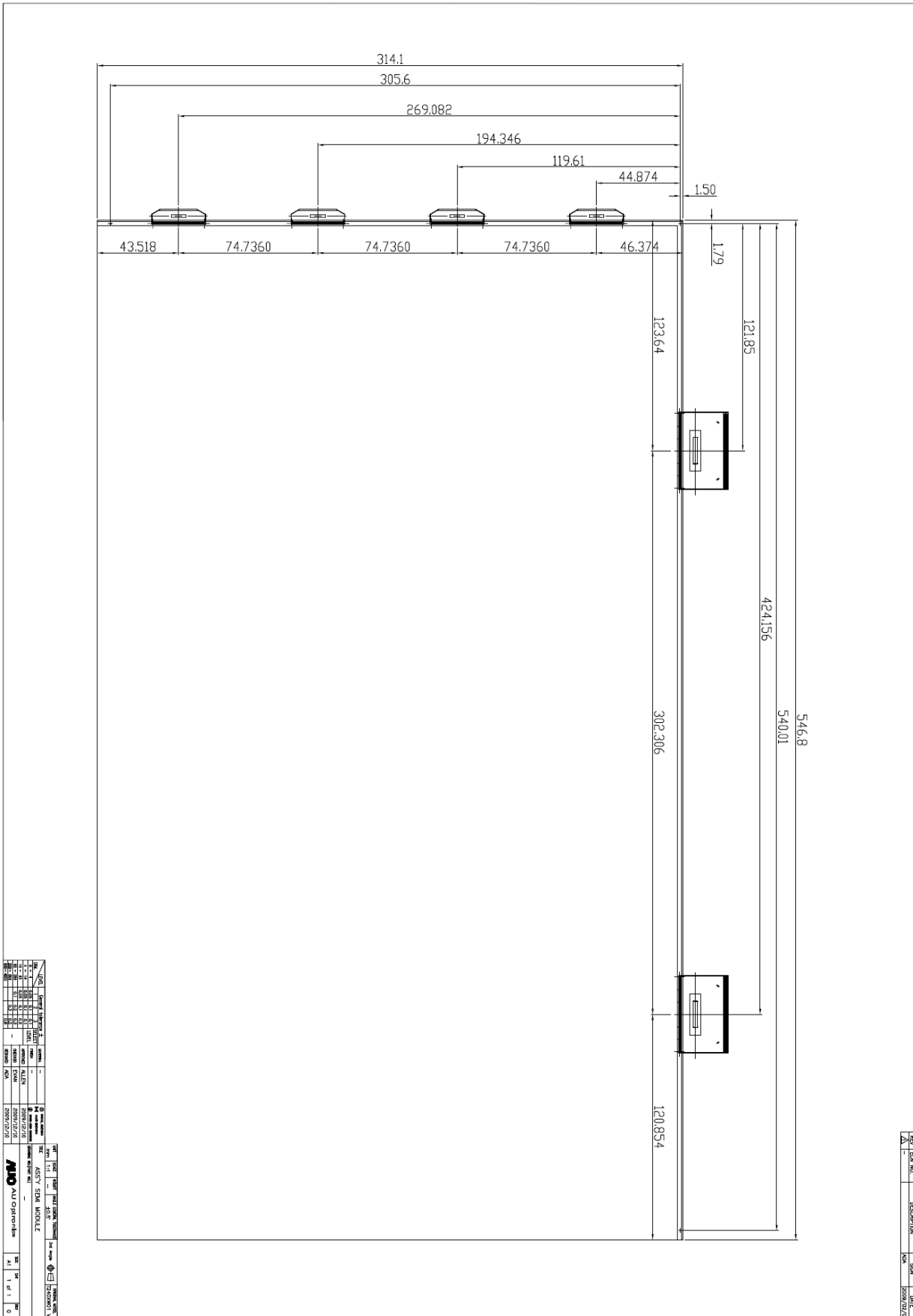
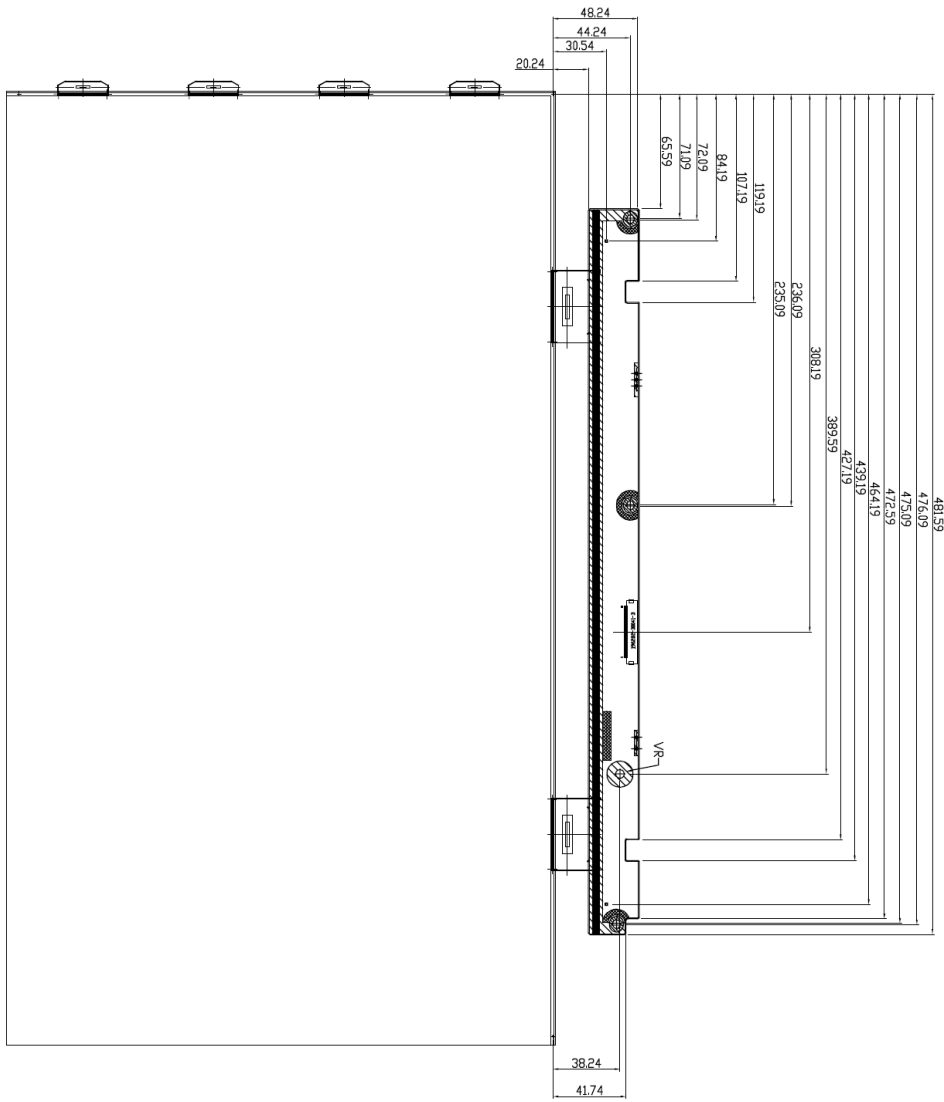

FIG.3 Viewing Angle



5. Open Cell Drawing





- NOTE
- 1 NO COMPONENT AREA
 - 2 NO SR AREA AND THE WIDTH OF THOSE LEADS WITH LAYOUT
 - 3 GROUND PATTERN WITH GOLD PLATING

REV	DATE	DESCRIPTION	BY	CHK
1.0	2009/02/25	Initial Release	W. Chen	J. Chen
1.1	2009/02/25	Revise PCB layout	W. Chen	J. Chen
1.2	2009/02/25	Revise PCB layout	W. Chen	J. Chen
1.3	2009/02/25	Revise PCB layout	W. Chen	J. Chen
1.4	2009/02/25	Revise PCB layout	W. Chen	J. Chen
1.5	2009/02/25	Revise PCB layout	W. Chen	J. Chen
1.6	2009/02/25	Revise PCB layout	W. Chen	J. Chen
1.7	2009/02/25	Revise PCB layout	W. Chen	J. Chen
1.8	2009/02/25	Revise PCB layout	W. Chen	J. Chen
1.9	2009/02/25	Revise PCB layout	W. Chen	J. Chen
1.10	2009/02/25	Revise PCB layout	W. Chen	J. Chen

REV	DATE	DESCRIPTION	BY	CHK
1.0	2009/02/25	Initial Release	W. Chen	J. Chen

6. Reliability Test Items

	Test Item	Q'ty	Condition
1	High temperature storage test	3	60°C , 300hrs
2	Low temperature storage test	3	-20°C , 300hrs
3	High temperature operation test	3	50°C , 300hrs
4	Low temperature operation test	3	-5°C , 300hrs
7	Vibration test (With carton)	24	Random wave (1.5G RMS, 10-200Hz) 30mins/ Per each X,Y,Z axes
8	Drop test (With carton)	24	Height: 45.7 cm 1 corner, 3 edges, 6 surfaces (ASTMD5276)

Note: Test item 1~4 Test item 1~4 RA tests are done on AUO 97.24T01.100 panels.

7. AUO's Basic BLU Optical Performance

The center luminance & Chromaticity of AUO's BLU

Item		Typ.	Unit	Note
Luminance		6900	nit	100% Dimming
Central Chromaticity (CIE 1930)	Item	min	typ	Max
	Wx	0.252	0.267	0.282
	Wy	0.236	0.251	0.266

8. Packing

8.1 DEFINITION OF LABEL:

A. Open cell shipping Label:



- (1) AUO internal code
- (2) Manufactured date
- (3) Model name

B. Carton Label:

AU Optronics	QTY:24
MODEL NO: T240XW01 VX	
PART NO: 91.24T01.XXX	
CUSTOMER NO:	
CARTON NO:	
Made in XXXXXX	*XXXXX-XXXXXXXXXX*

8.2 PACKING METHODS:

(A)

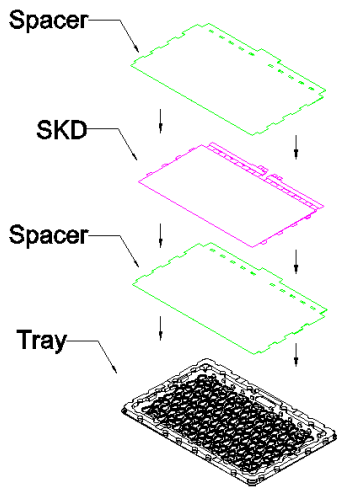

(B)

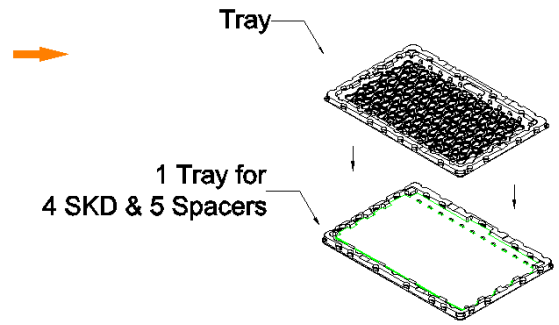

(C)

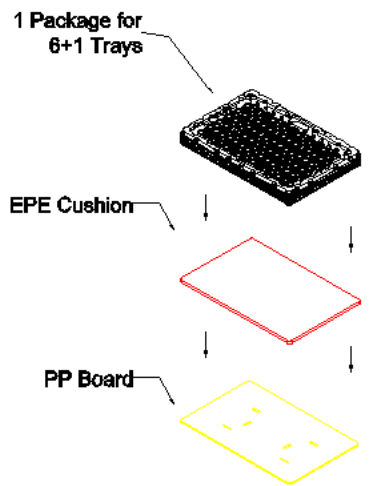

Total 24 SKD for 1 package

(D)

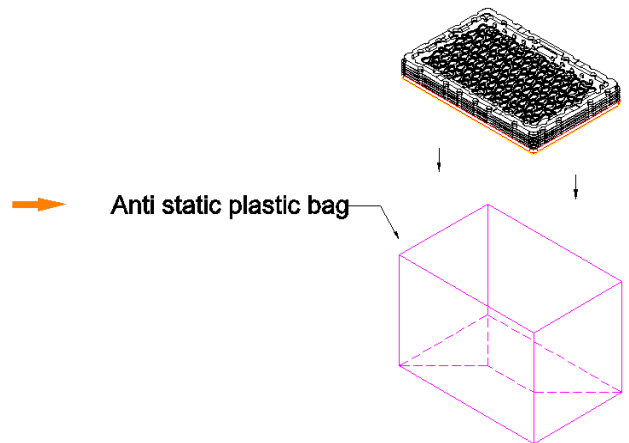

(E)

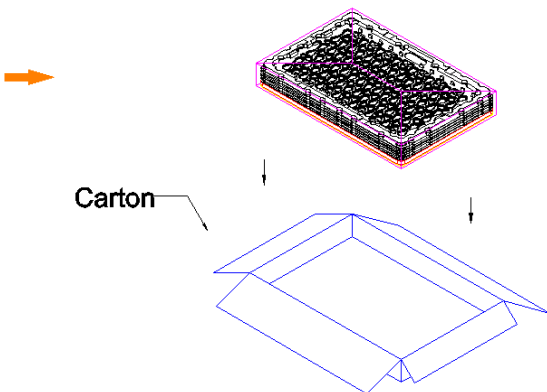

(F)

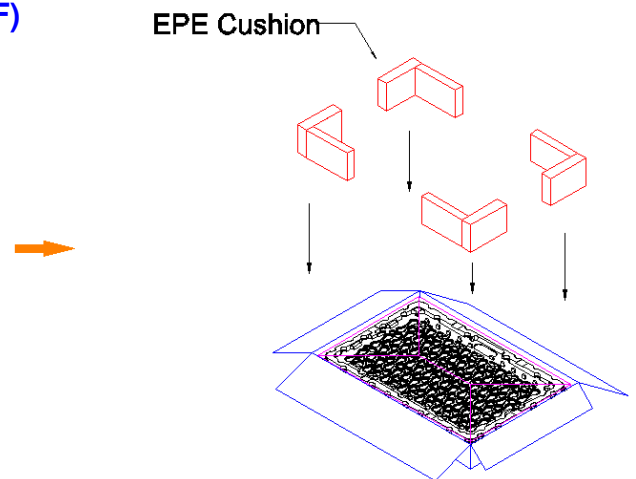

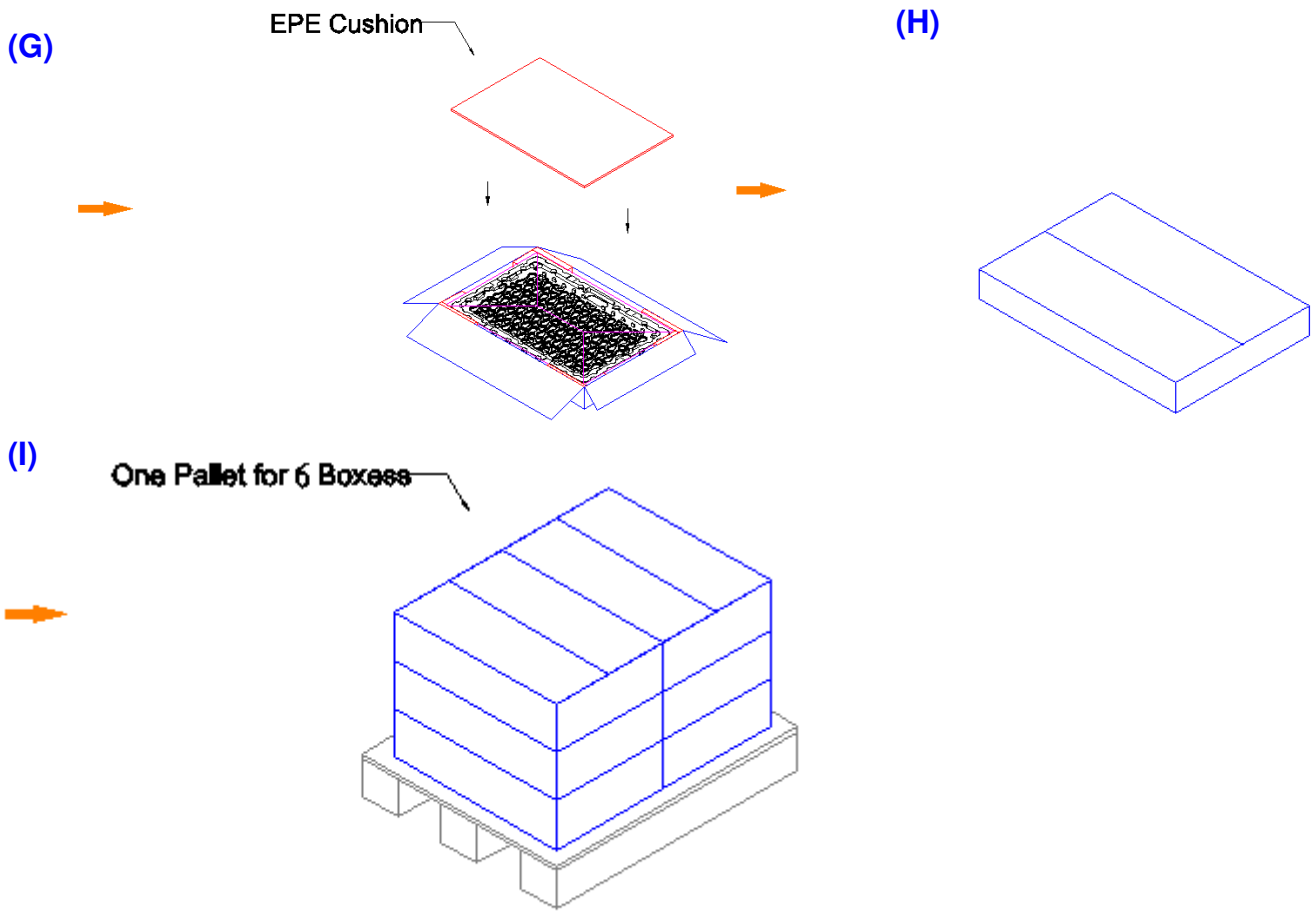

Pallet DIM : 1070*740 mm (S37)

Carton: 720(L)mm*520(W)mm*290(H)mm

Pallet: 1070mm*740mm*132mm

(1) By Air: (2*1) *3 layers, 6boxes per pallet, total 144pcs open cell per pallet

(2) By Sea: (2*1) *3 layers, 6boxes per pallet, double pallets, total 288pcs open cell per pallet

9. PRECAUTIONS

Please pay attention to the followings when you use this TFT LCD Open Cell unit.

9-1 MOUNTING PRECAUTIONS

- (1) You should consider the mounting structure so that uneven force (ex. Twisted stress) is not applied to the cell. And the frame on which a cell is mounted should have sufficient strength so that external force is not transmitted directly to the cell.
- (2) Please attach the surface transparent protective plate to the surface in order to protect the polarizer. Transparent protective plate should have sufficient strength in order to resist external force.
- (3) You should adopt radiation structure to satisfy the temperature specification.
- (4) Acetic acid type and chlorine type materials for the cover case are not desirable because the former generates corrosive gas of attacking the polarizer at high temperature and the latter causes circuit break by electro-chemical reaction.
- (5) Do not touch, push or rub the exposed polarizers with glass, tweezers or anything harder than HB pencil lead. And please do not rub with dust clothes with chemical treatment. Do not touch the surface of polarizer for bare hand or greasy cloth. (Some cosmetics are detrimental to the polarizer.)
- (6) When the surface becomes dusty, please wipe gently with absorbent cotton or other soft materials like chamois soaks with petroleum benzene. Normal-hexane is recommended for cleaning the adhesives used to attach front/ rear polarizers. Do not use acetone, toluene and alcohol because they cause chemical damage to the polarizer.
- (7) Wipe off saliva or water drops as soon as possible. Their long time contact with polarizer causes deformations and color fading.
- (8) Do not open the case because inside circuits do not have sufficient strength.

9-2 OPERATING PRECAUTIONS

- (1) The open cell unit listed in the product specification sheets was designed and manufactured for TV application
- (2) The spike noise causes the mis-operation of circuits. It should be lower than following voltage:
 $V = \pm 200\text{mV}$ (Over and under shoot voltage)
- (3) Response time depends on the temperature. (In lower temperature, it becomes longer.)
- (4) Brightness depends on the temperature. (In lower temperature, it becomes lower.) And in lower temperature, response time (required time that brightness is stable after turned on) becomes longer.
- (5) Be careful for condensation at sudden temperature change. Condensation makes damage to polarizer or electrical contacted parts. And after fading condensation, smear or spot will occur.
- (6) When fixed patterns are displayed for a long time, remnant image is likely to occur.
- (7) Module has high frequency circuits. Sufficient suppression to the electromagnetic interference shall be done by system manufacturers. Grounding and shielding methods may be important to minimize the interface.

9-3 ELECTROSTATIC DISCHARGE CONTROL

Since a open cell unit is composed of electronic circuits, it is not strong to electrostatic discharge. Make certain that treatment persons are connected to ground through wrist band etc. And don't touch interface pin directly.

9-4 PRECAUTIONS FOR STRONG LIGHT EXPOSURE

Strong light exposure causes degradation of polarizer and color filter.

9-5 STORAGE

When storing open cell units as spares for a long time, the following precautions are necessary.

- (1) Store them in a dark place. Do not expose the open cell unit to sunlight or fluorescent light. Keep the temperature between 5°C and 35°C at normal humidity.
- (2) The polarizer surface should not come in contact with any other object. It is recommended that they be stored in the container in which they were shipped.

9-6 HANDLING PRECAUTIONS FOR PROTECTION FILM OF POLARIZER

The protection film of polarizer is still attached on the surface as you receive open cell units. When the protection film is peeled off, static electricity is easily generated on the polarizer surface. This should be peeled off slowly and carefully by people who are electrically grounded and with well ion-blown equipment or in such a condition, etc.